

TFS-Dialog 400

Door terminal system

Advanced Information

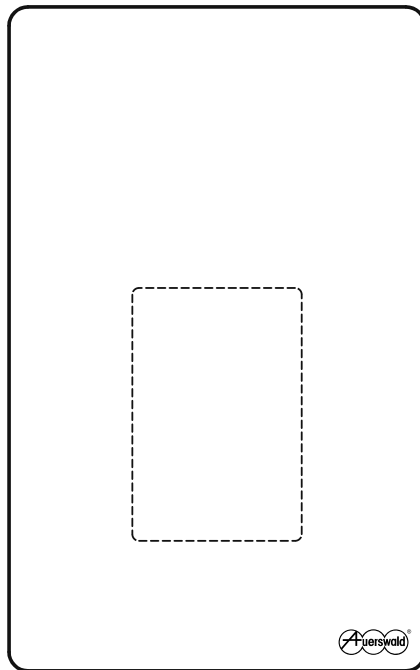

Table of Contents

About these instructions	4
Copyright	4
Trademarks	4
Instructions	4
Functions and Applications	5
Power supply operating modes	5
Sensor and label panel	6
Protection from unauthorised access	7
Code lock	8
Door bell buttons	9
Light	12
Door opener	13
Additional bell	14
Door conversation	16
Intercom	18
Ringer stop	19
a/b switching modules	20
Configuration	22
Configuring the door terminal in the PBX	22
COMpact 4000/5000/5000R/5200/5200R/5500R and COMmander 6000/R/RX (device template)	23
Other PBXs	23
Configuration via the TFS Set app	24
LED states during programming	26

Configuration via an internal telephone.....	27
Changing the default PIN	27
Performing the configuration	29
Device configuration.....	30
Restoring factory settings.....	32
Short reference	34
Configuration in configuration mode	34
Button configuration > Button layout	35
Button configuration > Destination number	36
Button configuration > Switching functions.....	36
Button configuration > Sounds	37
Extended > PIN	37
Extended > Dialling the destination number	38
Extended > Door opener	38
Extended > Light	39
Extended > Door call (intercom).....	39
Extended > Door conversation	40
Extended > End door conversation	40
Deleting data	41
Door conversation operation	41
Installation	42
Control with a/b switching modules.....	42
Setting switching frequencies	43
Connecting the ringer, door opener and stair light timer.....	43
External door opener button and ringer stop contact	45
Index	46

About these instructions

These instructions include additional information relating to the instructions in the TFS-Dialog 400 scope of delivery.

Copyright

Auerswald GmbH & Co. KG, 38162 Cremlingen, Germany, 2020

Trademarks

Android is a trademark of Google, Inc. iOS is a registered trademark of Cisco in the USA and some other countries and is used under license. All other trademarks mentioned are the property of the relevant manufacturer.

Instructions

You will find the up-to-date instructions on our website.

Functions and Applications

This section describes the various functions and applications of the device. You will learn what the functions do and how you can go about the configuration.

Topics

- [Power supply operating modes \(Seite 5\)](#)
- [Sensor and label panel \(Seite 6\)](#)
- [Protection from unauthorised access \(Seite 7\)](#)
- [Code lock \(Seite 8\)](#)
- [Door bell buttons \(Seite 9\)](#)
- [Light \(Seite 12\)](#)
- [Door opener \(Seite 13\)](#)
- [Additional bell \(Seite 14\)](#)
- [Door conversation \(Seite 16\)](#)
- [Intercom \(Seite 18\)](#)
- [Ringer stop \(Seite 19\)](#)
- [a/b switching modules \(Seite 20\)](#)

Power supply operating modes

The device has two power supply operating modes:

- a/b port and door bell transformer
- a/b port

The behaviour of some of the device's functions depends on the power supply operating mode:

	a/b port and door bell transformer	a/b port
Permanent assignment of the a/b line		X
Indirect lighting	X	
Label panel lighting	X	X (cannot be controlled)
TFS call-enabled	X	Only in configuration mode

Configuration procedure:

- Insert the jumper.
 - Into the device

Sensor and label panel

The device includes a sensor panel with 12 sensors. Another sensor can be found below the label panel and is not indicated by an LED.

The sensor and label panel has multiple functions. Some are available already in factory settings, while others first have to be configured.

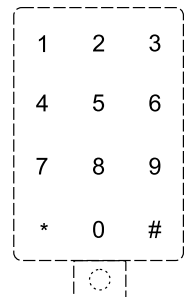

 **Note:** The star key (*) is assigned the cancel function while the device is being configured and in code lock mode. The hash key (#) is assigned the save function.

- Initiate configuration mode (key below the label panel)
- Code lock
 - Initiate code lock mode (key below the label panel)
 - PIN input
- Device configuration
 - PIN input
 - Settings
- Keys
 - Door bell button
 - Light key
 - Door opener button with ringer stop
 - Ringer stop key
 - Call end key
 - Manual call acceptance key (intercom)

Protection from unauthorised access

Since the device can be configured with the TFS Set app and is installed in a location which is accessible to all, it is imperative that you change the PIN for protection from unauthorised access.

 **Note:** Only programming mode can be activated on the device if the PIN has not been changed. No other functions will be available.

Configuration procedure:

- Change the PIN.
 - Via the TFS Set app (in menu **Extended > PIN**)
 - Via an internal telephone ([Extended > PIN \(Seite 37\)](#))

Code lock

Various functions (e.g. opening the door, turning on the light, opening other doors) can be performed via a code lock.

A maximum of 10 code locks can be configured for each device. Up to three functions are available for each code lock.



Note: The code lock is switched off in factory settings.

Configuration procedure:

- Enter name and code.
 - Via the TFS Set app (in menu **Code lock**)
- Set the switching functions.
 - Via the TFS Set app (in menu **Code lock**)

Procedure for entering the code lock PIN:

1. Press the key below the label panel.

- Using the buttons on the device, enter the programmed **code lock PIN** and confirm with **#**.

1	2	3
4	5	6
7	8	9
*	0	#

- Note:** The star key (*) is assigned the cancel function while the device is being configured and in code lock mode.
- Note:** Code lock mode remains active for 10 seconds. This time is reset after each input.
- Note:** If the code lock PIN is entered incorrectly, the device will only allow you to try again after a certain period of time. This time depends on the number of incorrect attempts:
 - 3 incorrect attempts = 1 minute
 - 5 incorrect attempts = 15 minutes
 - 7 incorrect attempts = 60 minutes
 - After each incorrect attempt thereafter, a 60-minute wait is required

Door bell buttons

The sensors on a horizontal row form a button panel and are used individually or grouped as a door bell button. If there are multiple door bell buttons, these are counted from top to bottom.

The device can be set individually to between 1 and 4 door bell buttons. Each door bell button is assigned a destination number which is called for the set maximal call duration when the door bell button is pressed.

The buttons can also be assigned switching functions. For example, the light can be switched on or off, the door can be opened or an additional bell can be activated by pressing a door bell button.

All functions are set individually for each door bell button.

When a door bell button is pressed, the signal sound is emitted as per the configuration and the following processes are initiated:

- The telephone configured for the door bell button rings for the set maximal call duration.
- The assigned switching functions are executed.

 **Note:** If a second door bell button is pressed before the receiver is picked up, hang up the device and repeat the process described above. If the same door bell button is pressed, the process is continued and not restarted.

 **Note:** If multiple door bell buttons are pressed at the same time, the process for the last key pressed is performed.

 **Note:** When detecting a voice, the device automatically establishes a voice connection. If necessary, the voice connection can also be established actively ([Door conversation operation \(Seite 41\)](#)).

Configuration procedure:

- Select the button layout.
 - Via the TFS Set app (in menu **Button configuration > Number of buttons**)
 - Via an internal telephone ([Button configuration > Button layout \(Seite 35\)](#))
- Assign destination number.

- Via the TFS Set app (in menu **Button configuration > Destination number**)
- Via an internal telephone ([Button configuration > Destination number \(Seite 36\)](#))
- Configure the maximal call duration.
 - Via the TFS Set app (in menu **Button configuration > Destination number**)
 - Via an internal telephone ([Button configuration > Destination number \(Seite 36\)](#))
- If necessary, assign the switching functions.
 - Via the TFS Set app (in menu **Button configuration > Switching functions**)
 - Via an internal telephone ([Button configuration > Switching functions \(Seite 36\)](#))
- Configure sounds.
 - Via the TFS Set app (in menu **Button configuration > Sounds**)
 - Via an internal telephone ([Button configuration > Sounds \(Seite 37\)](#))
- Set the pause between hanging up and picking up.

 **Note:** Once a connection has been established, each PBX requires a certain amount of time (also called hook/flash time) to detect that the telephone line is free again. You can set this pause time between 0.5 and 4.5 seconds. For this purpose, you can also consult the manual of the PBX.

- Via the TFS Set app (in menu **Extended > Dialling the destination number**)
- Via an internal telephone ([Extended > Dialling the destination number \(Seite 38\)](#))

Light

The light function is used for controlling a stair light timer, among other functions.

Connection options:

- Direct (see instructions)
- Via an a/b switching module ([Connecting the ringer, door opener and stair light timer \(Seite 43\)](#))

Light switching options:

- Press the door bell button/light button (automatic light). In addition to ringing, the light also switches. To make it a light button only, the destination number of the door bell button must be deleted.
- Enter the code lock PIN.
- Enter the character string in the internal telephone in a door conversation ([Door conversation operation \(Seite 41\)](#)).

Configuration procedure:

- Switch on the automatic light for the door bell button.
 - Via the TFS Set app (in menu **Button configuration > Switching functions**)
 - Via an internal telephone ([Button configuration > Switching functions \(Seite 36\)](#))
- Assign the light to a code lock PIN.
 - Via the TFS Set app (in menu **Code lock > Switching functions**)
- Assign the character string for switching the light via internal telephones.
 - Via the TFS Set app (in menu **Extended > Light**)

- Via an internal telephone ([Extended > Light \(Seite 39\)](#))
- Set the switching time light relay.
 - Via the TFS Set app (in menu **Extended > Light**)
 - Via an internal telephone ([Extended > Light \(Seite 39\)](#))

Door opener

The door opener function is used for controlling a door opener.

Connection options:

- Direct (see instructions)
- Via an a/b switching module ([Connecting the ringer, door opener and stair light timer \(Seite 43\)](#))

Options for opening the door:

- Press the door bell button (automatic door opener). This function can be switched on temporarily for the door bell button. During this time, no calls are sent to the configured destination number.
- Enter the code lock PIN.
- Press the key with the door opener function with ringer stop. When the door bell button assigned with this function is pressed, the door is opened without performing a call. If there is already an active call connection, this will be ended.
- Enter the character string in the internal telephone in a door conversation ([Door conversation operation \(Seite 41\)](#)).

Configuration procedure:

- Configure the key with the door opener function with ringer stop.

- Via an internal telephone ([Button configuration > Button layout \(Seite 35\)](#))
- Switch on/off the automatic door opener for the door bell button.
 - Via an internal telephone ([Door conversation operation \(Seite 41\)](#))
- Assign the door opener to a code lock PIN.
 - Via the TFS Set app (in menu **Code lock > Switching functions**)
- Assign the character string for opening the door via internal telephones.
 - Via the TFS Set app (in menu **Extended > Door opener**)
 - Via an internal telephone ([Extended > Door opener \(Seite 38\)](#))
- Set the switching time door opener relay.
 - Via the TFS Set app (in menu **Extended > Door opener**)
 - Via an internal telephone ([Extended > Door opener \(Seite 38\)](#))
- Set End when door opens.
 - Via the TFS Set app (in menu **Extended > End door conversation**)
 - Via an internal telephone ([Extended > End door conversation \(Seite 40\)](#))

Additional bell

The additional bell function is used for controlling an electronic ringer or gong, among other functions.

Connection options:

- Direct (see instructions)
- Via an a/b switching module ([Connecting the ringer, door opener and stair light timer \(Seite 43\)](#))

Switching options for an additional bell:

- Press the door bell button.
- Enter the code lock PIN.
- Enter the character string in the internal telephone in a door conversation ([Door conversation operation \(Seite 41\)](#)).
- Door call (intercom).

Configuration procedure:

- Switch on the additional bell for the door bell button.
 - Via the TFS Set app (in menu **Button configuration > Switching functions**)
 - Via an internal telephone ([Button configuration > Switching functions \(Seite 36\)](#))
- Assign an additional bell to a code lock PIN.
 - Via the TFS Set app (in menu **Code lock > Switching functions**)
- Switch on the additional bell when calling the door.
 - Via the TFS Set app (in menu **Extended > Door call (intercom)**)
 - Via an internal telephone ([Extended > Door call \(intercom\) \(Seite 39\)](#))
- Switch the additional bell via an a/b switching module.
 - Via the TFS Set app (in menu **Button configuration > Switching functions**)
 - Via an internal telephone ([Button configuration > Switching functions \(Seite 36\)](#))

Door conversation

A door conversation is a voice connection between the device and an internal telephone. During a door conversation, different functions such as opening the door can be activated from the internal telephone ([Door conversation operation \(Seite 41\)](#)).

 **Note:** During a door conversation, what is called an "attention sound" can be heard. This repeats every 60 seconds and can only be heard when the door conversation was not activated from the device itself. This is the case when the device is called and configured to either accept the call immediately or automatically after a certain amount of time (see [Intercom \(Seite 18\)](#)).

Options for initiating a door conversation:

- Pick up using the internal telephone called via the door bell button.
- Dial the door number on the internal telephone (see [Intercom \(Seite 18\)](#)).

Options for ending a door conversation:

- Time passed after opening the door.
- Duration of the maximal talk time.
- Press the key with the call end function.
- Enter the character string in the internal telephone in a door conversation ([Door conversation operation \(Seite 41\)](#)).

Configuration procedure:

- Configure the key with the call end function.

- Via an internal telephone ([Button configuration > Button layout \(Seite 35\)](#))
- Set the maximal talk time.
 - Via the TFS Set app (in menu **Extended > End door conversation**)
 - Via an internal telephone ([Extended > End door conversation \(Seite 40\)](#))

 **Note:** The maximal talk time is applied for security purposes. If the person using the telephone does not hang up after a call, the call is ended after this period of time and the device can be called again. The call can be extended by the set maximal talk time by dialling a character string ([Door conversation operation \(Seite 41\)](#)).

- Set End when door opens.
 - Via the TFS Set app (in menu **Extended > End door conversation**)
 - Via an internal telephone ([Extended > End door conversation \(Seite 40\)](#))
- Change the input sensitivity of the a/b port.
 - Via the TFS Set app (in menu **Extended > Door conversation**)
 - Via an internal telephone ([Extended > Door conversation \(Seite 40\)](#))

 **Important:** If it becomes necessary to change the volume, first change the input sensitivity of the a/b line. Once no more improvements can be made using this function, change the setting for the surroundings and the volume of the loudspeaker.

 **Important:** You can adapt the device to PBXs from other manufacturers that have different attenuation using the input sensitivity of the a/b line. This will be necessary in the following scenarios:

- Speech channels are not switched over or only when the speaker's volume is loud.

- The busy signal is not detected and the call is not ended by the device.
- Set the surroundings (affects the surroundings of the device).
 - Via the TFS Set app (in menu **Extended > Door conversation**)
 - Via an internal telephone ([Extended > Door conversation \(Seite 40\)](#))
- Change the volume of the loudspeaker.
 - Via the device ([Device configuration \(Seite 30\)](#))
 - Via an internal telephone ([Extended > Door conversation \(Seite 40\)](#))

Intercom

The device can be called from any internal telephone using its internal destination number. The call is signalled to the device by means of a recurring signal sound. An additional bell can also be installed and switched on.

Options for call acceptance from the device:

- Immediate (0 seconds): The voice connection is established automatically and immediately.
- Automatic according to timing (5 to 85 seconds): The voice connection is established by pressing any door bell button within the set time period. Once the set time period has elapsed, the call connection is established automatically.
- Manual (90 seconds): The voice connection is established by pressing any door bell button within the set time period. The call is ended if no door bell buttons are pressed within the set maximal call duration.



Note: The device accepts the call immediately as long as it is in configuration mode (4 minutes). Only once this period of time has elapsed can the call be handled as defined in the settings.

Configuration procedure:

- Switch on the additional bell.
 - Via the TFS Set app (in menu **Extended > Door call (intercom)**)
 - Via an internal telephone ([Extended > Door call \(intercom\)](#) ([Seite 39](#)))
- Switch the loudspeaker on/off.
 - Via the TFS Set app (in menu **Extended > Door call (intercom)**)
 - Via an internal telephone ([Extended > Door call \(intercom\)](#) ([Seite 39](#)))
- Set the call acceptance of the door terminal.
 - Via the TFS Set app (in menu **Extended > Door call (intercom)**)
 - Via an internal telephone ([Extended > Door call \(intercom\)](#) ([Seite 39](#)))

Ringer stop

A call is activated when a door bell button is pressed. If the door is not opened via the telephone but in some other way, the ringer is only stopped once the maximal call duration has elapsed. To always stop the ringer while the door is being opened, the ringer stop function can be used.

Options for configuring the ringer stop function:

- Key with ringer stop. If the key assigned with this function is pressed, the call is ended.
- Installed ringer stop contact ([External door opener button and ringer stop contact](#) ([Seite 45](#)))

Configuration procedure:

- Assign door bell button with ringer stop function.
 - Via an internal telephone ([Button configuration > Button layout \(Seite 35\)](#))

a/b switching modules

The device can integrate a number of additional switching functions (e.g. switching of additional bells, a door opener or stairwell lighting) using optional a/b switching modules, without any additional lines to the device having to be installed (see [Control with a/b switching modules \(Seite 42\)](#)).

An a/b switching module switches a device on if a signal with a specific frequency is sent over the line. Six different switching frequencies are available at the a/b switching modules.

Switching frequency 1–4	Free assignment
Switching frequency 5	Controlled when switching on the light.
Switching frequency 6	Controlled when opening the door.

Options for controlling an a/b switching module:

- Press the door bell button.
- Enter the code lock PIN.
- Enter the character string in the door conversation from the internal telephone ([Door conversation operation \(Seite 41\)](#))

Configuration procedure:

- Set the switching frequency.

- Via the DIL switch of the a/b switching module ([Setting switching frequencies \(Seite 43\)](#))
- Assign the switching frequency to a door bell button.
 - Via the TFS Set app (in menu **Button configuration > Switching functions**)
 - Via an internal telephone ([Button configuration > Switching functions \(Seite 36\)](#))
- Assign the switching frequency to a code lock PIN.
 - Via the TFS Set app (in menu **Code lock > Switching functions**)

Configuration

This section describes how to set up the PBX for operation of the device and how to configure the device with the TFS Set app or an internal telephone.

Topics

- [Configuring the door terminal in the PBX \(Seite 22\)](#)
- [Configuration via the TFS Set app \(Seite 24\)](#)
- [Configuration via an internal telephone \(Seite 27\)](#)
- [Device configuration \(Seite 30\)](#)
- [Restoring factory settings \(Seite 32\)](#)

Configuring the door terminal in the PBX

The device needs to be set up in the PBX configuration. The type of configuration varies for the different PBX systems and according to the firmware version of the PBX.

Topics

- [COMpact 4000/5000/5000R/5200/5200R/5500R and COMmander 6000/R/RX \(device template\) \(Seite 23\)](#)
- [Other PBXs \(Seite 23\)](#)

COMpact 4000/5000/5000R/5200/5200R/5500R and COMmander 6000/R/RX (device template)

In the COMpact 4000/5000/5000R/5200/5200R/5500R and COMmander 6000/R/RX PBX systems from firmware version 6.8B and later, a device template is saved for the device (Auerswald TFS-Dialog 400). With firmware version 6.4A and later, a device template is supported, but it may have to be downloaded and imported from the Internet.

If the device is being configured in these PBXs as a door terminal (under **Devices > Device wizard**), the device template should be used. The door terminal will then have an internal number, and call targets will be defined for the door bell buttons.

 **Important:** After the door terminal has been set up in the PBX configuration, the door terminal call distribution is controlled – both in terms of the call targets and the call duration – entirely by the PBX. The default destination numbers (31–34) in the device must not be modified.

Other PBXs

In the COMpact 4000, 5000/R and COMmander 6000/R/RX PBXs with a firmware version later than 6.4A, and in other Auerswald PBXs, device templates are not supported. The door terminal must be configured as an analogue subscriber here.

 **Note:** CLIP info must be switched off for the analogue subscribers in question (under **Subscriber (scr.) > Properties > Analogue settings**). Otherwise, errors may occur when the door is called.

 **Note:** Make sure that the busy signal is switched on for call end for the analogue subscribers in question.

To configure the device for PBXs from other manufacturers, please consult the corresponding instructions.

Configuration via the TFS Set app

To perform the configuration via the TFS Set app, the device must be in configuration mode. The device can be configured via the TFS Set app using a smartphone (or tablet).

The instructions of the device describe how to configure the device for the first time using the TFS Set app. All other settings can be selected from the menu as described in these instructions under the individual functions. Once complete, the configuration can then be transmitted and/or shared to the device (**Transmit configuration** menu). A variety of saving options are available with the file manager installed on the smartphone.

The following actions are not possible with the TFS Set app:

- Resetting the device to factory settings
- Changing the device volume
- Changing the device brightness
- Configuring the key layout with ringer stop, door opener and call end functions

Requirements:

- Smartphone with operating system Android version 5.0 and above or iOS version 9.0 or above
 - TFS Set app installed
 - Device closed and screwed shut
1. Make the correct settings in the app.
 2. Go to the **Transmit configuration** menu.

3. Transmit the data as shown in the figure.

i **Note:** We recommend that you use a headset for the transmission, if the smartphone has more than one loudspeaker.

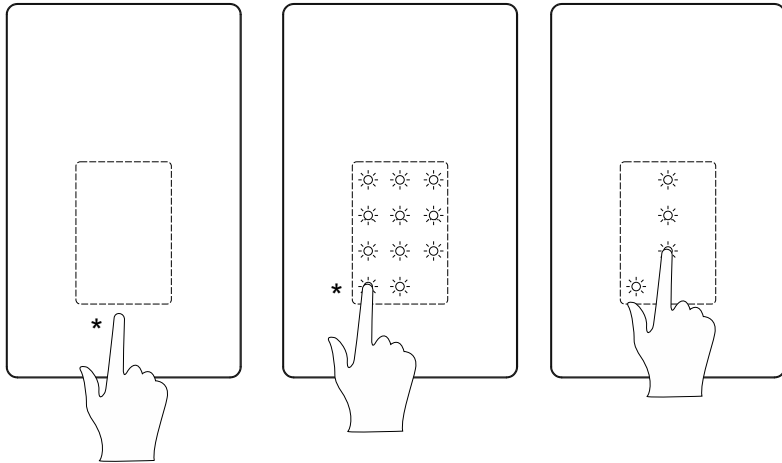

* Press and hold the key until the display changes

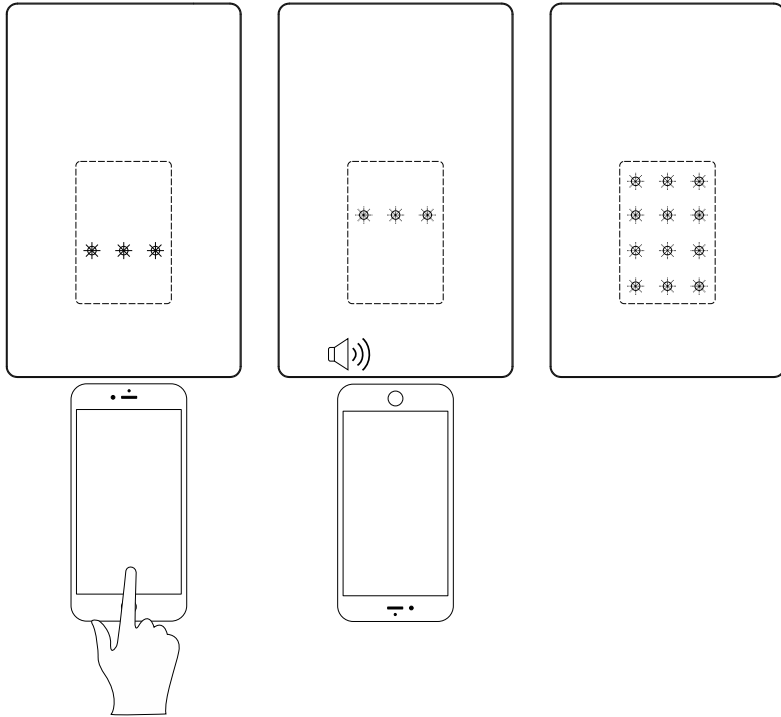

LED states during programming

If the data has not transferred correctly, the LEDs in the third row continue to blink. To try again, adjust the transmission speed and/or the transmission volume on your smartphone.

If data has not transferred correctly, all the LEDs in the second row light up. The LED displaying the error flashes:

Left-hand LED	Incorrect PIN
Middle LED	Incorrect app version

Configuration via an internal telephone

To perform the configuration via an internal telephone, the device must be in configuration mode.

The following actions are not possible via an internal telephone:

- Configuring the code lock function
- Saving the existing configuration for later use
- Changing the device brightness

 **Important:** You must first change the default PIN. You will not be able to operate the device if the default PIN is not changed (for protection from unauthorised access). Other configurations can be performed before changing the PIN, but they will not be available to you until it is changed.

Topics

- [Changing the default PIN \(Seite 27\)](#)
- [Performing the configuration \(Seite 29\)](#)

Changing the default PIN

Requirement:

- An internal telephone with DTMF signalling configured for the PBX

1. Press the keys on the device as shown in the figure.

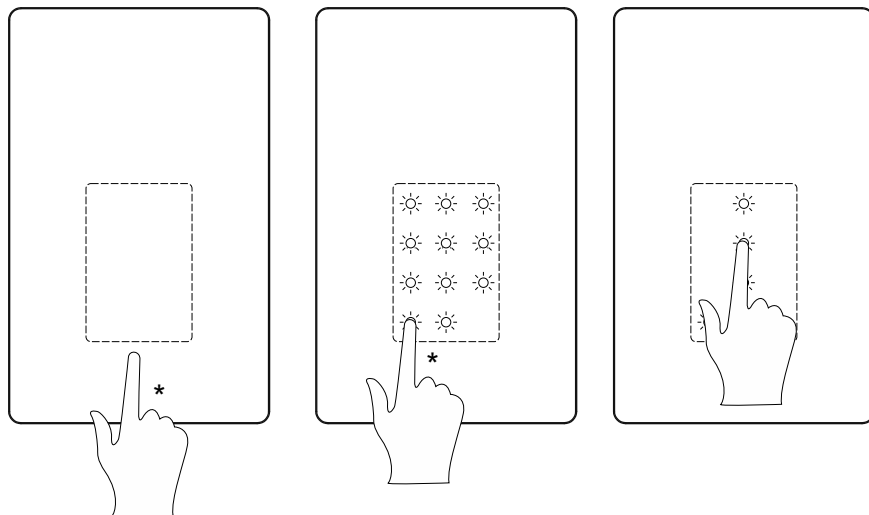

* Press and hold the key until the display changes

2. Pick up the telephone receiver within 4 minutes.
3. Dial the **internal number** of the device.
This establishes the connection.
4. Dial *** 0000 ***.
You will hear the confirmation tone (five rapid, sequential sounds).
5. Dial **29 <new PIN> # <repeat new PIN> #**.
6. Wait until you hear the confirmation tone and then hang up.

Performing the configuration

Requirement:

- An internal telephone with DTMF signalling configured for the PBX

1. Press the keys on the device as shown in the figure.

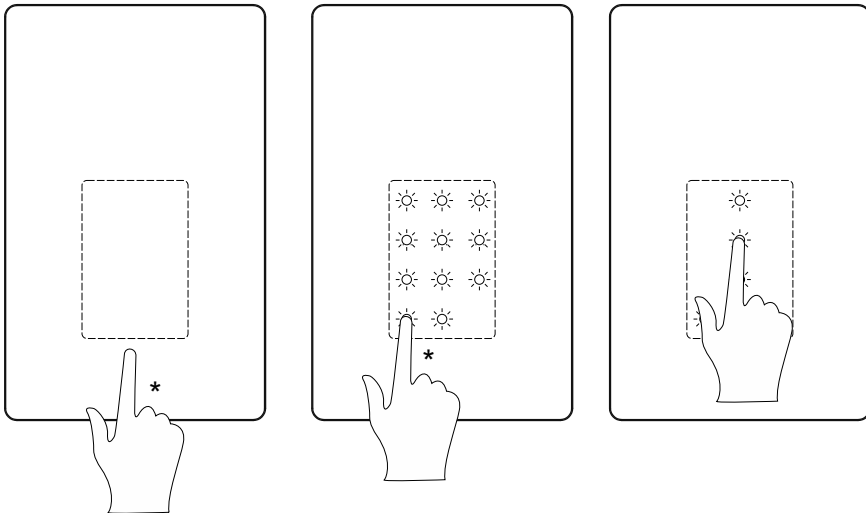

* Press and hold the key until the display changes

2. Pick up the telephone receiver within 4 minutes.

3. Dial the **internal number** of the device.

This establishes the connection.

4. Dial *** PIN ***.

You will hear the confirmation tone (five rapid, sequential sounds).

5. Specify a function and a value (see Chapter Short reference > [Configuration in configuration mode \(Seite 34\)](#)).

6. Additional settings can be configured by entering * within the 4-minute window.

 **Note:** If you make an incorrect entry, instead of the confirmation tone you will hear a busy signal for 1–2 seconds. Then begin again by dialling *.

 **Note:** After you hear a confirmation tone, configuration mode remains active for another 4 minutes. You automatically leave configuration mode if you do not perform any configuration actions during this time, or if you press the door bell buttons.

Device configuration

Only the volume and brightness device properties can be set directly in the device without using an internal telephone or the app.

Requirements:

- The default PIN (0000) has been changed

1. Press the buttons on the device as shown in the figure.

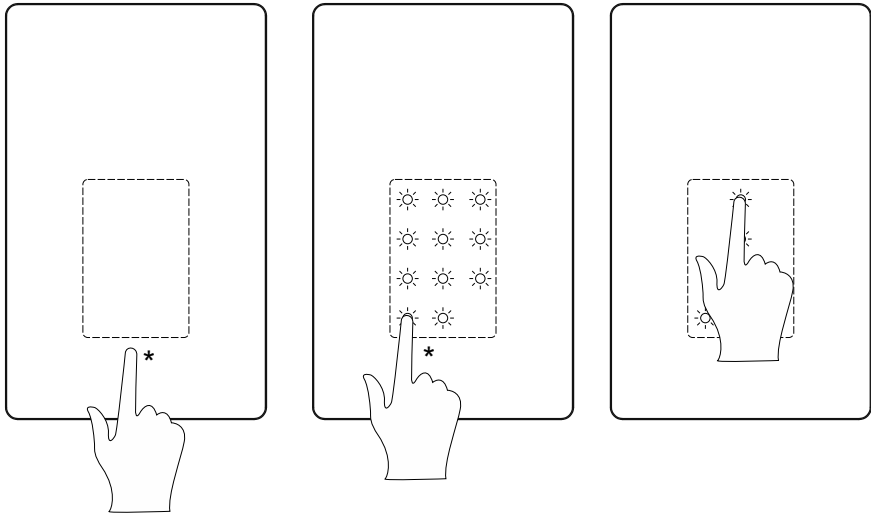

* Press and hold the key until the display changes

2. Use the buttons on the device to enter the **PIN** and confirm with **#**.

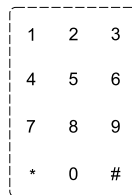

i **Note:** The star key (*) is assigned the cancel function while the device is being configured and in code lock mode.

3. Activate a property field (A, B or C) and then set the brightness or volume using the + and - keys.

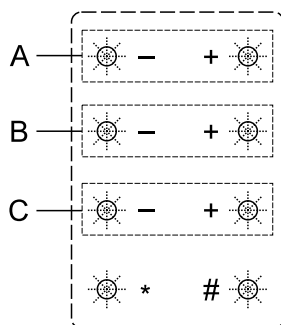

- A** Indirect lighting
- B** Label panel lighting
- C** Loudspeaker volume

4. Confirm with **#**.

i **Note:** When operating the device without the door bell transformer, indirect lighting will not be available and the label panel lighting cannot be controlled.

Restoring factory settings

Requirement:

- An internal telephone with DTMF signalling configured for the PBX

1. Press the default key on your device until all LEDs start to blink and the flashing rhythm changes.

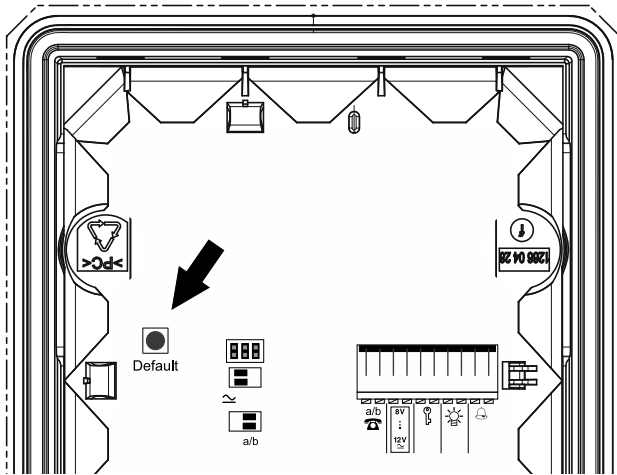

2. Call the device using its phone number and then dial **## ***.
3. You can then hang up.

Short reference

This section lists all character strings used to configure and operate the device by means of an internal telephone.

Topics

- [Configuration in configuration mode \(Seite 34\)](#)
- [Door conversation operation \(Seite 41\)](#)

Configuration in configuration mode

Topics

- [Button configuration > Button layout \(Seite 35\)](#)
- [Button configuration > Destination number \(Seite 36\)](#)
- [Button configuration > Switching functions \(Seite 36\)](#)
- [Button configuration > Sounds \(Seite 37\)](#)
- [Extended > PIN \(Seite 37\)](#)
- [Extended > Dialling the destination number \(Seite 38\)](#)
- [Extended > Door opener \(Seite 38\)](#)
- [Extended > Light \(Seite 39\)](#)
- [Extended > Door call \(intercom\) \(Seite 39\)](#)
- [Extended > Door conversation \(Seite 40\)](#)
- [Extended > End door conversation \(Seite 40\)](#)
- [Deleting data \(Seite 41\)](#)

Button configuration > Button layout

Name/default	Function	Value x
Button layout / door bell buttons 1–4	61x (row 1)	0 (no function)
	62x (row 2)	1–4 (door bell buttons 1–4)
	63x (row 3)	5 (ringer stop)
	64x (row 4)	6 (door opener with ringer stop) 7 (call end)

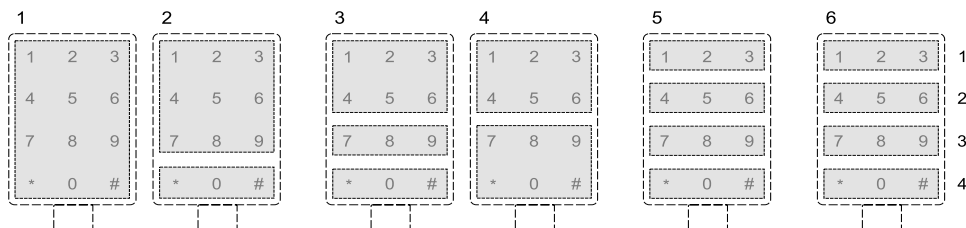

Fig.	Sensor field assignment	61	62	63	64
1	1 door bell button in the entire sensor field	1	1	1	1
2	1 door bell button (bottom) + address field (top)	0	0	0	1
3	2 door bell buttons (bottom) + address field (top)	0	0	1	2
4	2 door bell buttons	1	1	2	2
5	3 door bell buttons + address field (very top)	0	1	2	3
6	4 door bell buttons	1	2	3	4

Button configuration > Destination number

Name/default	Function	Value x
Destination number / 31–34	21x... (Key 1) 22x... (Key 2) 23x... (Key 3) 24x... (Key 4) Then hang up!	0–9, *, #, Wait 5 s (= dialling pause) (phone number with 0 to 32 digits)
Maximal call duration / 60 s	46xx (Key 1) 47xx (Key 2) 48xx (Key 3) 49xx (Key 4)	01 (1 s) ... 90 (90 s)

Button configuration > Switching functions

Name/default	Function	Value x
Automatic light / off	71x (Key 1) 72x (Key 2) 73x (Key 3) 74x (Key 4)	0 (off) 1 (on)
Additional bell / off	41x (Key 1) 42x (Key 2) 43x (Key 3) 44x (Key 4)	0 (off) 1 (on)

Name/default	Function	Value x
Function / off	31x (Key 1)	0 (off)
	32x (Key 2)	1, 2, 3, 4 (switching frequency 1, 2, 3, 4)
	33x (Key 3)	
	34x (Key 4)	

Button configuration > Sounds

Name/default	Function	Value x
Signal sound / on	76x (Key 1)	0 (off)
	77x (Key 2)	1 (on)
	78x (Key 3)	
	79x (Key 4)	

Extended > PIN

Name/default	Function	Value x
PIN / 0000	29x...#x...#	0–9 (PIN with 4 to 6 digits, entered twice)

Extended > Dialling the destination number

Name/default	Function	Value x
Pause between picking up or hanging up / 0.5 s	54x	1 (x 0.5 = 0.5 s), ..., 9 (x 0.5 = 4.5 s)

Extended > Door opener

Name/default	Function	Value x
Character string for opening the door via internal telephones / (#)8	26x...#	0–9 (character string with 1 to 6 digits)
Switching time door opener relay / 2 s	56x	1 (x 0.5 = 0.5 s), ..., 9 (x 0.5 = 4.5 s)

 **Important:** If the switch-on time is prolonged, it is necessary to change the relay dead time of the door opener relay (applies to COMpact 4000, 5000/R, 5200/R, 5500/R and COMmander 6000/R/RX PBXs from firmware version 6.4A – see Advanced Information relating to the PBX). The connected door opener must support switch-on time configuration.

 **Note:** The character string of the door opener function must differ from that of the light function.

Extended > Light

Name/default	Function	Value x
Character string for switching via internal telephones / (#)9	25x...#	0–9 (character string with 1 to 6 digits)
Switching time light relay / 0.5 s	55x	1 (x 0.5 = 0.5 s), ..., 9 (x 0.5 = 4.5 s)

 **Note:** The character string of the light function must differ from that of the door opener function.

Extended > Door call (intercom)

Name/default	Function	Value x
Additional bell / off	60x	0 (off) 1 (on)
Loudspeaker / on	28x	0 (off) 1 (on)
Call acceptance of the door terminal / immediate	52xx	00 (immediate), 01 (1 s) ... 89 (89 s), 90 (manual call acceptance only)

Extended > Door conversation

Name/default	Function	Value x
Input sensitivity of the a/b port / low (3)	50x	0 (low) ... 9 (high)
Quiet surrounding / off	58x	0 (off) 1 (on)
Loudspeaker volume / quiet (2)	57x	0 (quiet) to 9 (loud)

Extended > End door conversation

Name/default	Function	Value x
Maximal talk time / 3 min	51x	0 (unlimited), 1 (1 min) to 9 (9 min)
End when door opens / off (busy signal detection)	59x	0 (0 s) to 8 (8 s) 9 (off (busy signal detection))

i Note: If no door opener is connected to the device, the value for "End when door opens" must be set to off. If the value is not set to off, no call connection will be established.

i Note: If a door conversation is automatically ended by a door being opened and the light is also switched on, the time for "End when door opens" must be configured to longer than two seconds.

Deleting data

Name	Function
Deleting data (PIN is retained)	91 Then hang up!

Door conversation operation

Description	Function	Value x
Automatic door opener	##5PIN*1x (Key 1) ##5PIN*2x (Key 2) ##5PIN*3x (Key 3) ##5PIN*4x (Key 4) ##5PIN*0x (All buttons)	0 (off) 1 (on)
Trigger additional bell	##61	
Door terminal loudspeaker	*x	0 (off) 1 (on)
Extend call duration	*2	
Switch a/b switching module	##x	1–4 (switching frequency 1–4)
Switch on the light	#8	
Open the door	#9	
End a call	#*	
Establish active voice connection	1	

Installation

 **Warning:** Using the wrong door bell transformer could pose a fire hazard.

- Only approved intrinsically safe bell transformers according to the standards DIN EN 61558-2-8 or VDE 0570 T2-8 with a maximum rated power of 100 W/VA may be used.

This section is supplementary to the installation described in the instructions.

Topics

- [Control with a/b switching modules \(Seite 42\)](#)
- [External door opener button and ringer stop contact \(Seite 45\)](#)

Control with a/b switching modules

 **Warning:** Improper handling of the device can result in life-threatening electrical shock, or damage or destroy the device.

- When connecting an a/b switching module, please also refer to the safety information and technical data in the a/b switching module instruction manual.

You can install up to six switchable a/b switching modules, which are available as accessories, on the 2-core cable between the PBX and device to implement additional switching functions.

Setting switching frequencies

The switching frequency is set via the DIL switch on the a/b switching module.



Switching frequency 1



Switching frequency 2



Switching frequency 3



Switching frequency 4



Switching frequency 5



Switching frequency 6

Connecting the ringer, door opener and stair light timer

! **Important:** An a/b switching module can only maintain a switching operation for 0.5 to 4.5 seconds.

- If a switching operation needs to last longer, use a time relay such as a stair light timer.

! **Important:** The a/b switching modules only need a very low quiescent current for problem-free operation. If an electronic ringer or an electronic stair light timer with a high internal resistance is connected, it is possible that the a/b switching module will not function correctly.

- Each a/b switching module is supplied with an additional resistor to resolve this problem. Connect this resistor to the terminal clamps on the electronic ringer or electronic stair light timer. This ensures that a minimal quiescent current is provided for the a/b switching module.

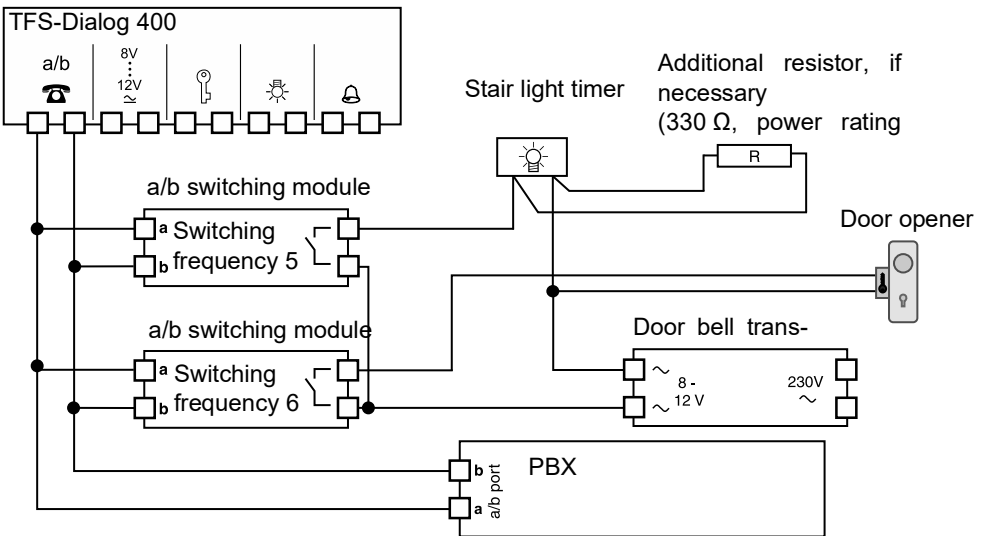
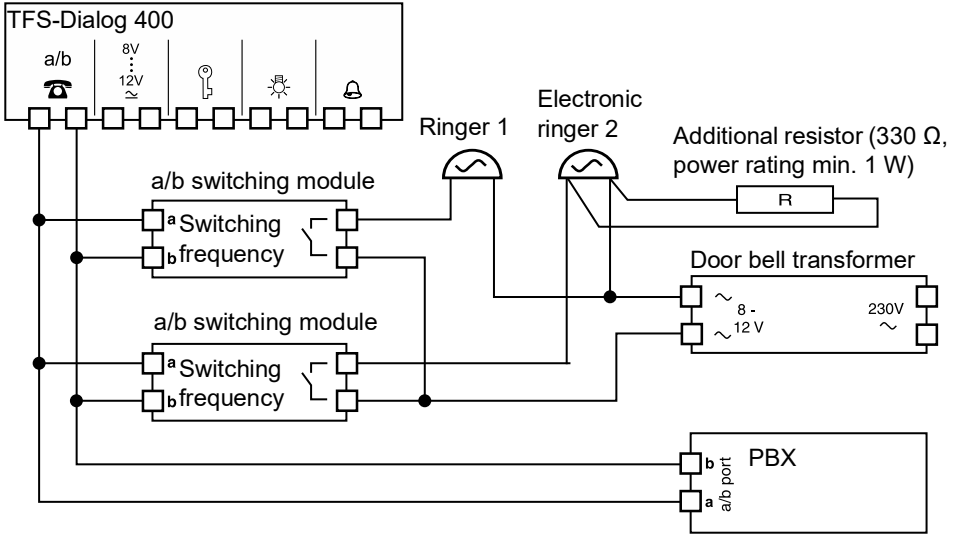

External door opener button and ringer stop contact

If the door is opened by an external door opener button, the following will occur:

- The door is opened.
- The ringer is ended immediately.
- An existing door conversation is ended after the configured time (End when door opens).

The same sequence can be achieved by manually opening the door when a ringer stop contact is installed. This contact is connected in series with the door opener and must be closed with the door closed and opened when the door is opened.

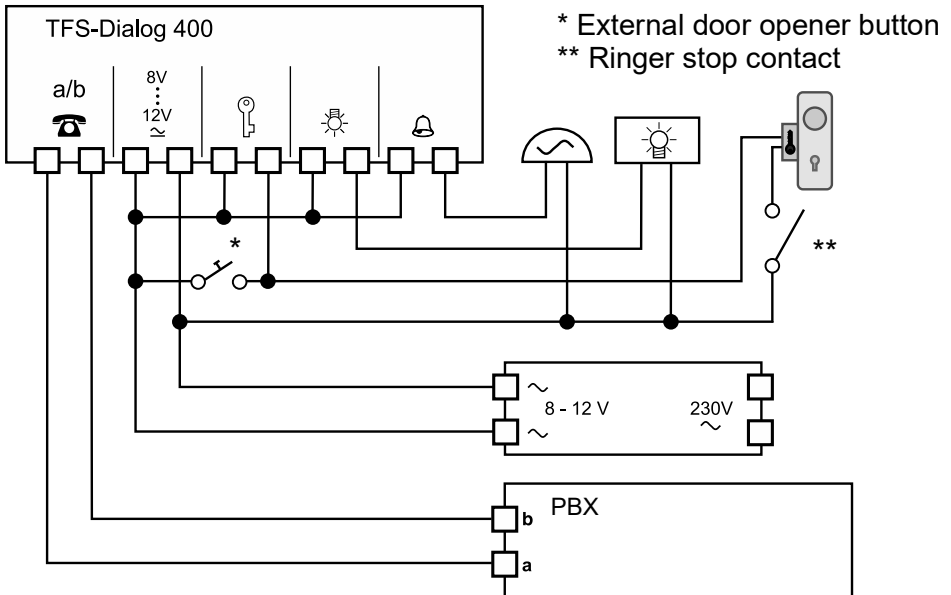

Index

A	
a/b switching modules	20
About these instructions	4
Additional bell	19
B	
Brightness	30
Button configuration	
Destination number	36
Sounds	37
C	
Changing the PIN	37
Code lock	19
Configuration	
App	24
Telephone	27, 34

D	
Default PIN	30
Deleting data	41
Door conversation	
Configuration	40
End door conversation	40
Function	16
Operation while on a call	41
Door opener	
Configuration	38
Function	13
Door opener button	45
F	
Factory settings	32
I	
Intercom	
Configuration	39
Function	18
L	
Light	
Configuration	39
Function	12

P	
Power supply operating modes	5
Protection from unauthorised access	7
R	
Ringer stop	19
Ringer stop contact	45
S	
Sensor and label panel	6
Button layout	35
Door bell buttons	9
T	
TFSSet app	24
V	
Volume	
Loudspeaker	30, 40
Surroundings	40